

STANDARD
OFFICE POD

FRONT ELEVATION

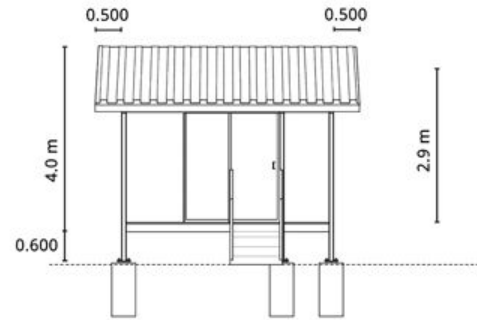

WINDOW & DOOR SCHEDULE

Elevation	Description	Window/Door	Dimensions (mm)
FRONT	LIVING	DOOR	1800w x 2040h
W. SIDE	LIVING	WINDOW	900w x 300h
REAR	BATH	WINDOW	300h x 600h

W. SIDE ELEVATION

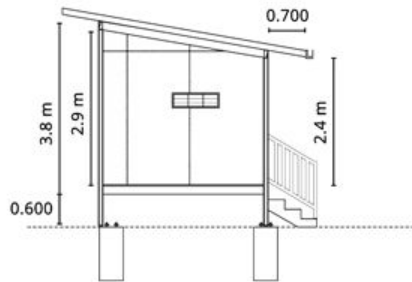

E. SIDE ELEVATION

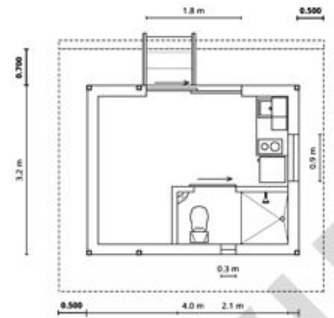
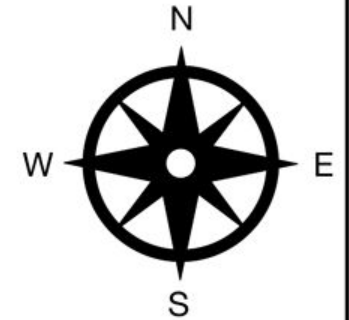
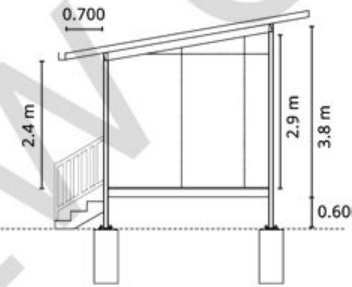

REAR ELEVATION

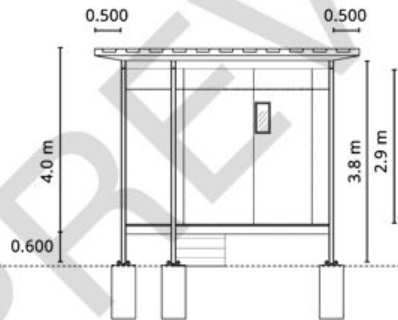

MANFRED AUCH • FREIER ARCHITEKT

SACHVERSTÄNDIGER FÜR DIE BEWERTUNG VON BEBAUTEN UND UNBEBAUTEN GRUNDSTÜCKEN, MIETEN UND PACHTEN
VORSITZENDER DES GUTACHTERAUSSCHUSSES DER STADT WEINSTADT

Strümpfelbacher Straße 64 71324 WEINSTADT - ENDERSBACH Tel. 07151 - 969 80-0 Fax 07151 - 969 80 20

Project: Office POD Floor Plan Layout

Date: 27/06/2020 Scale: 1:50

Designer: ieshahomes Plan: 1

CARPORT
OFFICE POD

FRONT ELEVATION

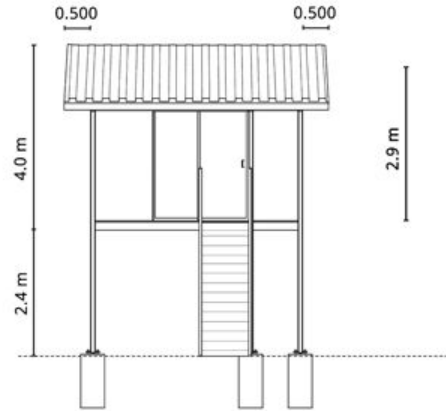

WINDOW & DOOR SCHEDULE

Elevation	Description	Window/Door	Dimensions (mm)
FRONT	LIVING	DOOR	1800w x 2040h
W. SIDE	LIVING	WINDOW	900w x 300h
REAR	BATH	WINDOW	300h x 600h

W. SIDE ELEVATION

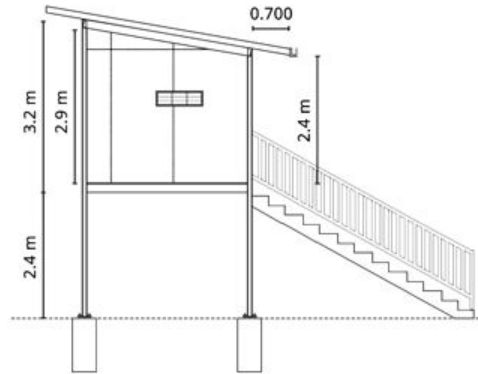

E. SIDE ELEVATION

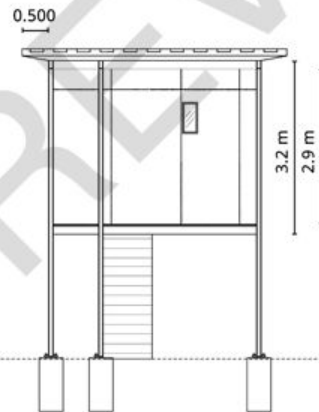
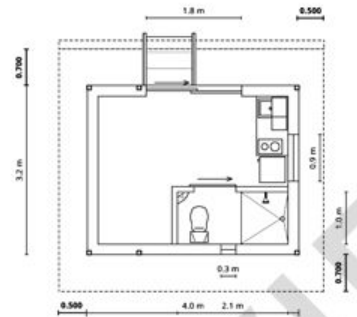
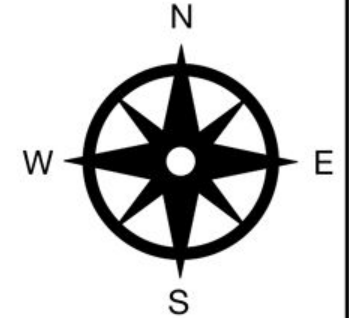
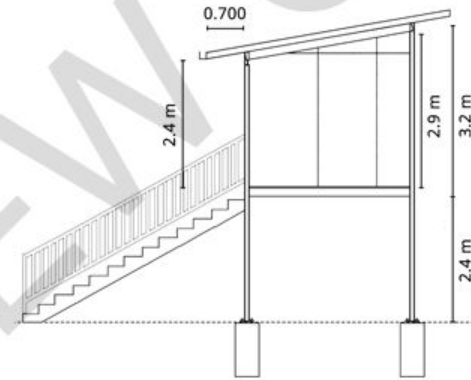

REAR ELEVATION

MANFRED AUCH • FREIER ARCHITEKT

SACHVERSTÄNDIGER FÜR DIE BEWERTUNG VON BEBAUTEN UND UNBEBAUTEN GRUNDSTÜCKEN, MIETEN UND PACHTEN
VORSITZENDER DES GUTACHTERAUSSCHUSSES DER STADT WEINSTADT

Strümpfelbacher Straße 64 71324 WEINSTADT - ENDERSBACH Tel. 07151 - 969 80-0 Fax 07151 - 969 80 20

Project: Office POD Floor Plan Layout

Date: 27/06/2020 Scale: 1:50

Designer: ieshahomes

Plan:

1

FRONT ELEVATION

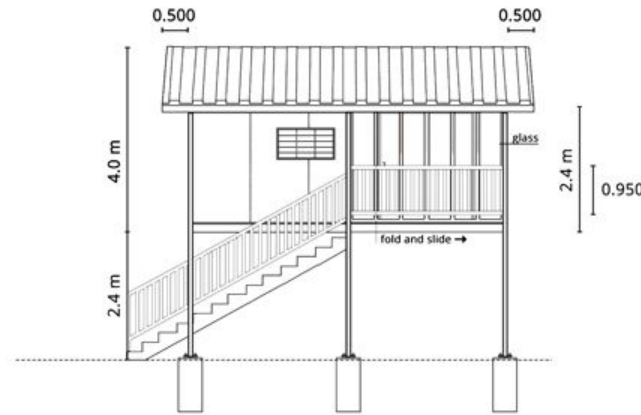

WINDOW & DOOR SCHEDULE

Elevation	Description	Window/Door	Dimensions (mm)
FRONT	LIVING	WINDOW	1100w x 600h
FRONT	LIVING	DOOR	1800w x 2040h
W. SIDE	LIVING	WINDOW	900w x 300h
REAR	LIVING	WINDOW	900w x 300h
REAR	BATH	WINDOW	300w x 600h

W. SIDE ELEVATION

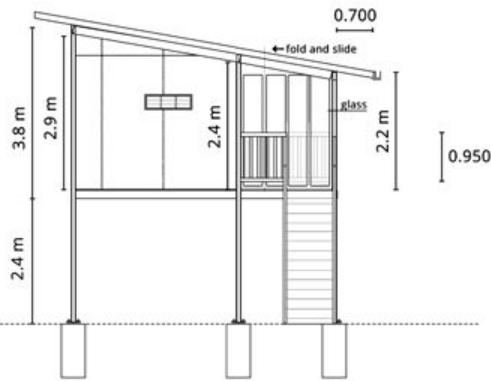

E. SIDE ELEVATION

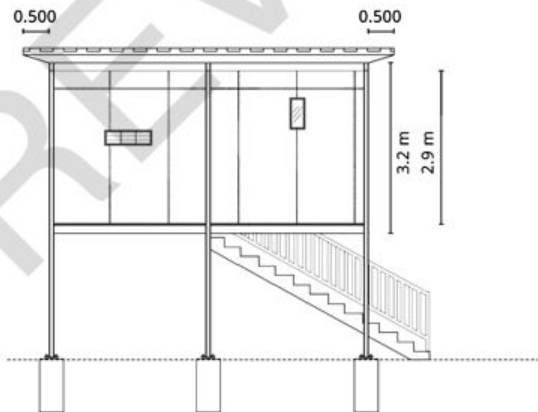
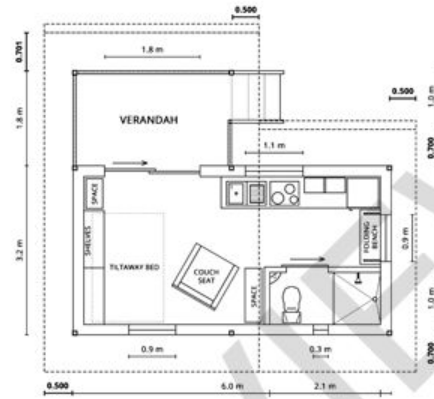
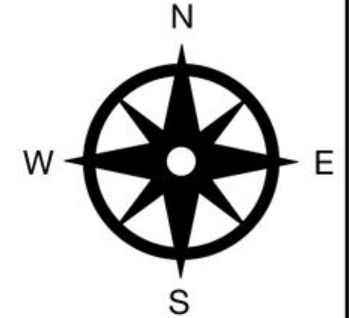
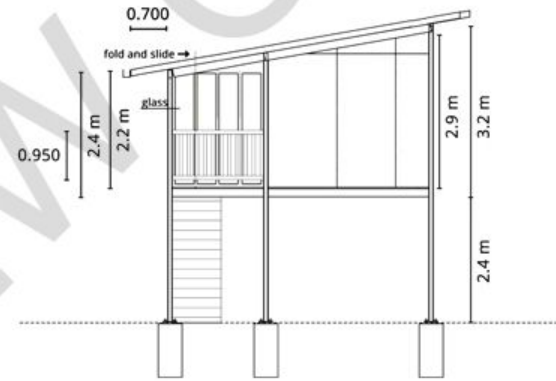

REAR ELEVATION

MANFRED AUCH • FREIER ARCHITEKT

SACHVERSTÄNDIGER FÜR DIE BEWERTUNG VON BEBAUTEN UND UNBEBAUTEN GRUNDSTÜCKEN, MIETEN UND PACHTEN
VORSITZENDER DES GUTACHTERAUSSCHUSSES DER STADT WEINSTADT

Strümpfelbacher Straße 64 71324 WEINSTADT - ENDERSBACH Tel. 07151 - 969 80-0 Fax 07151 - 969 80 20

Project: **Studielle POD Floor Plan Layout**

Date: 27/06/2020 Scale: 1:50

Designer: **ieshahomes** Plan: **1**

FRONT ELEVATION

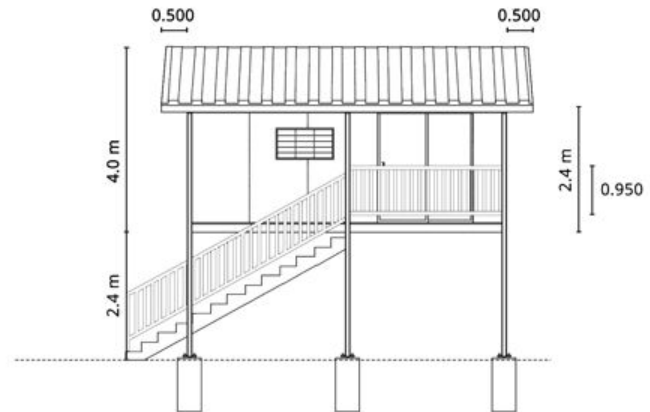

WINDOW & DOOR SCHEDULE

Elevation	Description	Window/Door	Dimensions (mm)
FRONT	LIVING	WINDOW	1100w x 600h
FRONT	LIVING	DOOR	1800w x 2040h
W. SIDE	LIVING	WINDOW	900w x 300h
REAR	LIVING	WINDOW	900w x 300h
E. SIDE	BATH	WINDOW	400w x 600h

W. SIDE ELEVATION

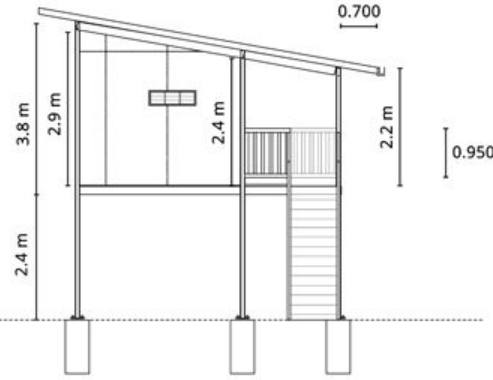

E. SIDE ELEVATION

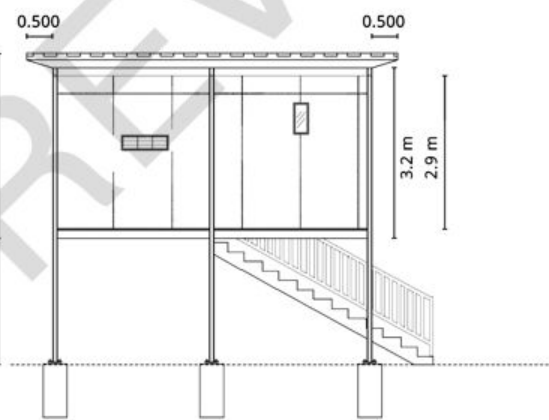
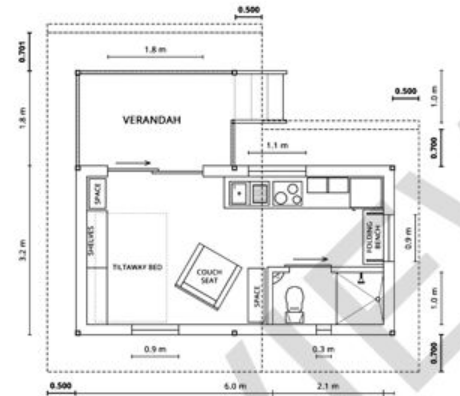
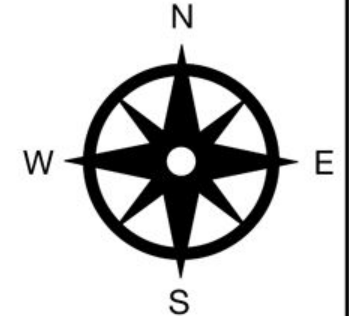
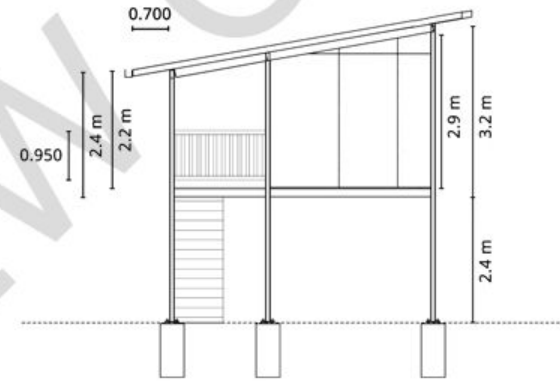

REAR ELEVATION

MANFRED AUCH • FREIER ARCHITEKT
 SACHVERSTÄNDIGER FÜR DIE BEWERTUNG VON BEBAUTEN UND UNBEBAUTEN GRUNDSTÜCKEN, MIETEN UND PACHTEN
 VORSITZENDER DES GUTACHTERAUSSCHUSSES DER STADT WEINSTADT

Strümpfelbacher Straße 64 71324 WEINSTADT - ENDERSBACH Tel. 07151 - 969 80-0 Fax 07151 - 969 80 20

Project: **Studielle POD Floor Plan Layout**

Date: 27/06/2020 Scale: 1:50

Designer: **ieshahomes** Plan: **1**

FRONT ELEVATION

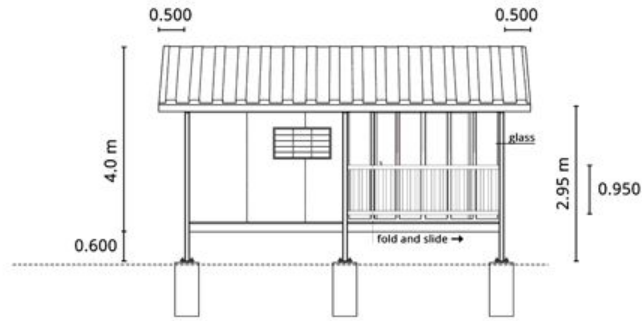

WINDOW & DOOR SCHEDULE

Elevation	Description	Window/Door	Dimensions (mm)
FRONT	LIVING	WINDOW	1100w x 600h
FRONT	LIVING	DOOR	1800w x 2040h
W. SIDE	LIVING	WINDOW	900w x 300h
REAR	LIVING	WINDOW	900w x 300h
REAR	BATH	WINDOW	300w x 600h

W. SIDE ELEVATION

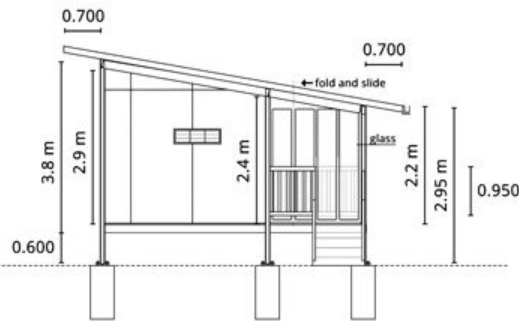

E. SIDE ELEVATION

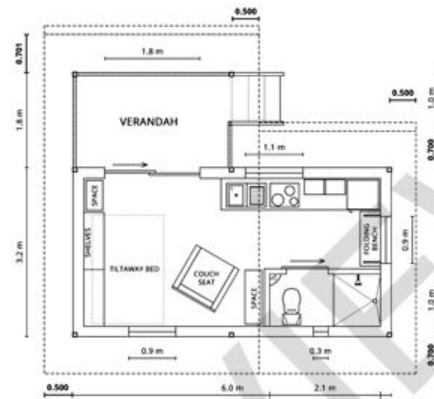
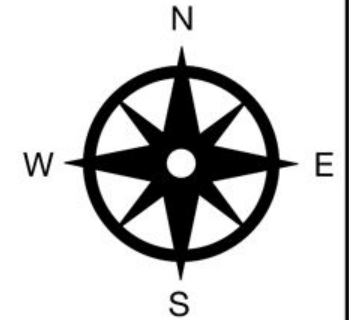
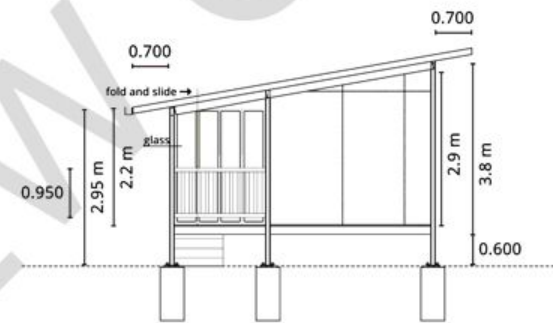

REAR ELEVATION

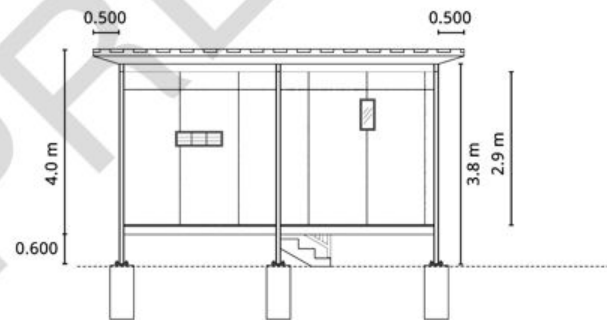

MANFRED AUCH • FREIER ARCHITEKT

SACHVERSTÄNDIGER FÜR DIE BEWERTUNG VON BEBAUTEN UND UNBEBAUTEN GRUNDSTÜCKEN, MIETEN UND PACHTEN
VORSITZENDER DES GUTACHTERAUSSCHUSSES DER STADT WEINSTADT

Strümpfelbacher Straße 64 71324 WEINSTADT - ENDERSBACH Tel. 07151 - 969 80-0 Fax 07151 - 969 80 20

Project: **Studielle POD Floor Plan Layout**

Date: 27/06/2020 Scale: 1:50

Designer: **ieshahomes** Plan: **1**

FRONT ELEVATION

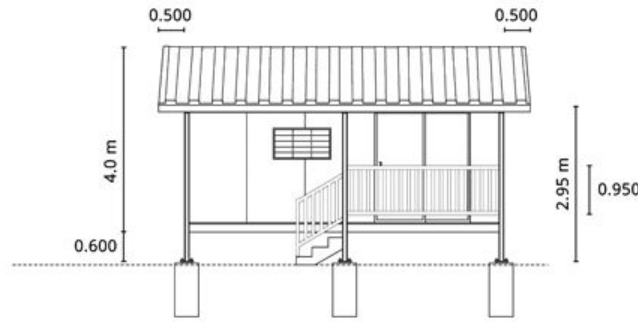

WINDOW & DOOR SCHEDULE

Elevation	Description	Window/Door	Dimensions (mm)
FRONT	LIVING	WINDOW	1100w x 600h
FRONT	LIVING	DOOR	1800w x 2040h
W. SIDE	LIVING	WINDOW	900w x 300h
REAR	LIVING	WINDOW	900w x 300h
REAR	BATH	WINDOW	300w x 600h

W. SIDE ELEVATION

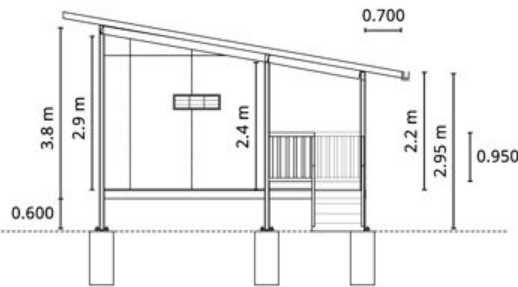

E. SIDE ELEVATION

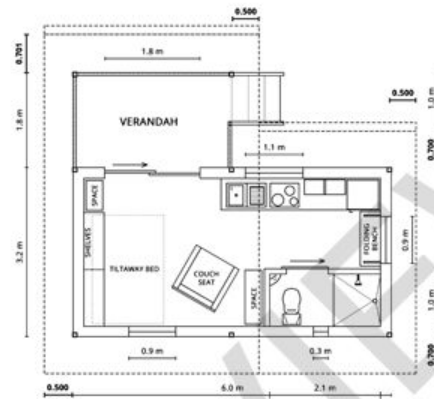
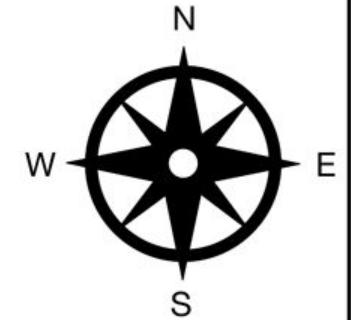
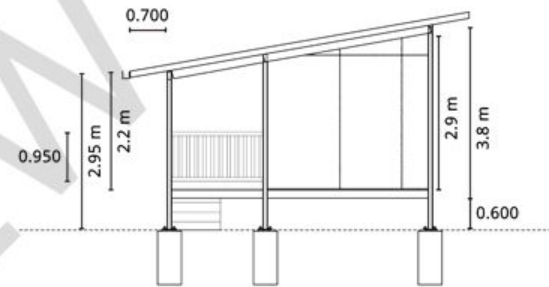

REAR ELEVATION

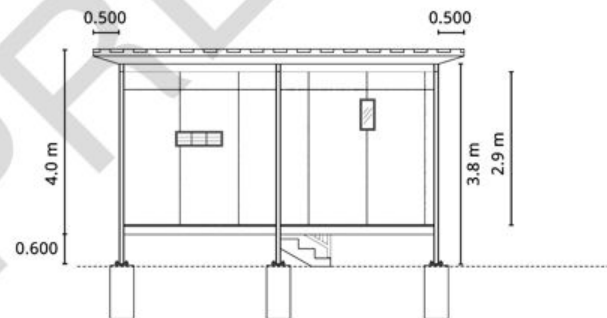

MANFRED AUCH • FREIER ARCHITEKT

SACHVERSTÄNDIGER FÜR DIE BEWERTUNG VON BEBAUTEN UND UNBEBAUTEN GRUNDSTÜCKEN, MIETEN UND PACHTEN
VORSITZENDER DES GUTACHTERAUSSCHUSSES DER STADT WEINSTADT

Strümpfelbacher Straße 64 71324 WEINSTADT - ENDERSBACH Tel. 07151 - 969 80-0 Fax 07151 - 969 80 20

Project: **Studielle POD Floor Plan Layout**

Date: 27/06/2020 Scale: 1:50

Designer: **ieshahomes** Plan: **1**